

## DC Series Power Distribution

features:

- Multiple voltage outputs (5V, 12V, 18V, & 24V, depending on model) supported in a single box form factor
- Color-coded screw terminal connectors with industry standard voltages & polarity labeling for easy identification
- MOV surge and overload protection on the AC input and auto-resetting PTC overload protection on each individual DC output
- USB charging ports provided to conveniently power compatible products (not for data transfer)
- AC convenience outlets provided (PD-DC-45 only)
- LED indicator lights showing activity on each output and alerting maximum capacity on each voltage bank
- Hardware kit includes flexible mounting hardware, color-coded screw terminal connectors to connect devices, and a 6ft IEC power cord



specifications:

DC Power Distribution power management products shall be Middle Atlantic Products model # PD-DC\_\_\_ (refer to chart). DC Power Distribution products shall be \_\_\_"H x \_\_\_"W x \_\_\_"D (refer to drawing). DC Power shall output \_\_\_ watts, refer to chart. DC Power shall provide MOV surge and overload protection and resettable PTC overload protection on each individual DC output. PD-DC-45 shall provide 6qty 5VDC outputs, 6qty 12VDC outputs, 3qty NEMA 5-15R outlets, and 2qty USB outputs and support mounting to the side of the enclosure with hooks or push-pins. DC Power outputs shall be color coded. PD-DC-125R shall provide 6qty 5VDC outputs, 6qty 12VDC outputs, 6qty 18VDC outputs, 6qty 24VDC outputs, and 4qty USB outputs and rackmount flush or recessed, or mount to the side of the enclosure. DC Power shall include a 6' removable IEC power cord with a NEMA 5-15P plug. DC Power shall include a thermostatically controlled fan and have a maximum sound level of 28 dBA. DC Power shall be EU RoHS Directive 2011/65/EU compliant. DC Power shall be manufactured by an ISO 9001& 14001 registered company. DC Power shall be warranted to be free from defects in materials and workmanship under normal use and conditions for a period of 3 years. DC Power strip shall be UL Listed to UL 60950-1 in the US and CAN/CSA C22.2 No. 60950-1 in Canada and FCC Class B.

Customizable specification clips available at [middleatlantic.com](http://middleatlantic.com)



## DC Series

### Power Distribution

# PD-DC-45

basic dimensions

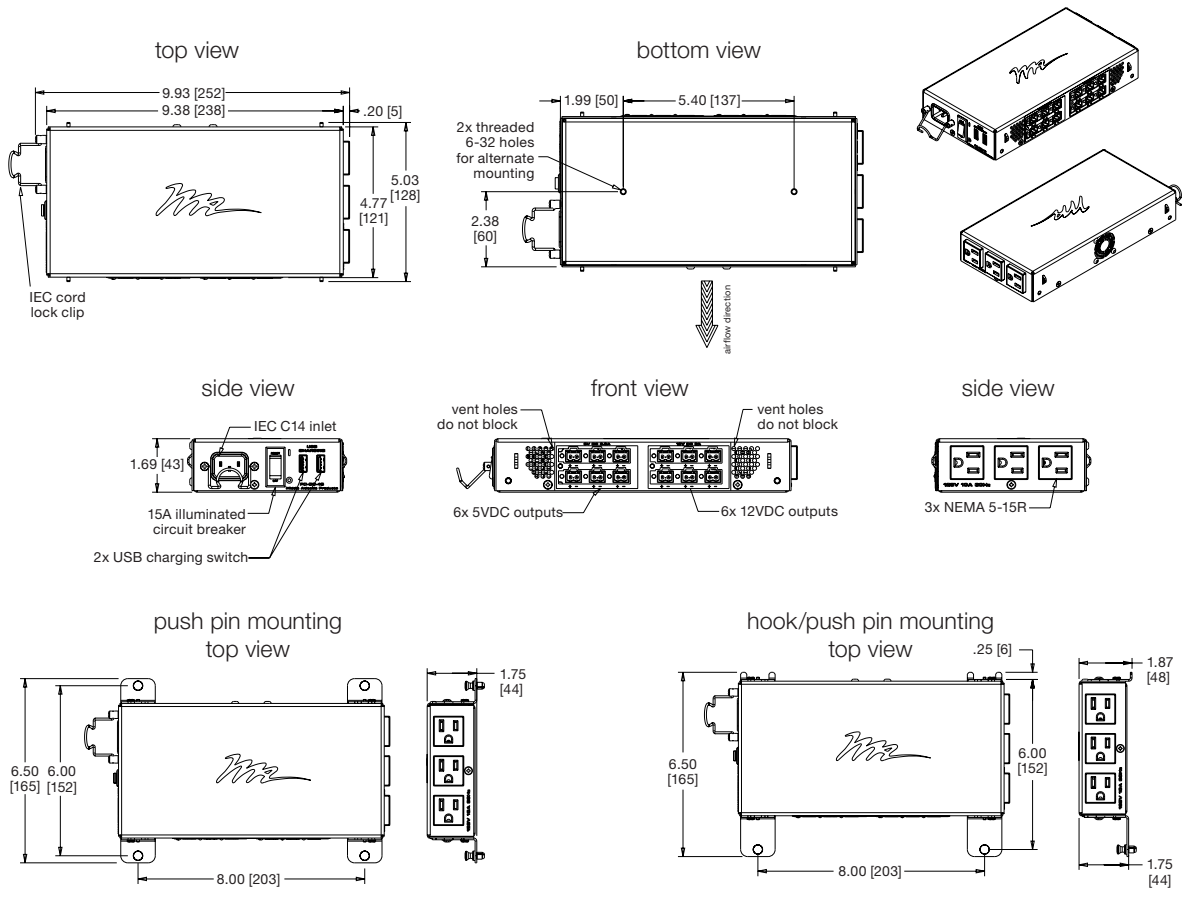

all dimensions in inches unless otherwise noted [all dimensions in brackets are in millimeters]

Notes:  
1. Thermostatically controlled fan for cooling. Do not block fan or vent holes.  
Maximum sound level: 28 DBA @ 1 meter

Specification	Details
Line Voltage	120VAC/60Hz (Min. 100Vac, Max. 132VAC)
Current Rating	12A Max (8A Max With DC Only Fully Loaded)
AC Input Connector	IEC C-14
Power Cord Length	6 Feet
Surge Protection	MOV, Mode L-N, Clamping Voltage 595V
Total DC Output Current	5.2A DC
Total DC Output Power	45W
DC Output Over Current Protection	Automatically Resetting PTC Fuse on Each Output
AC Output, Total	10A/120VAC/60HZ
Idle Current	.080A Ac

DC Outputs			
Voltage	Max Current Total (Rail)	Max Current Per Output	Rail Current Warning
5V DC	3A	2A	2.85A
12V DC	2A	1.5A	1.9A
USB 5V DC	2.5A	2.1A	N/A

Caution! Do Not Exceed Maximum Ratings

# DC Series

## Power Distribution

### PD-DC-125R

basic dimensions

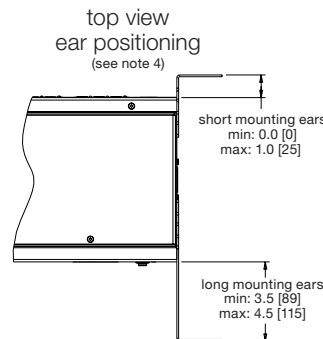
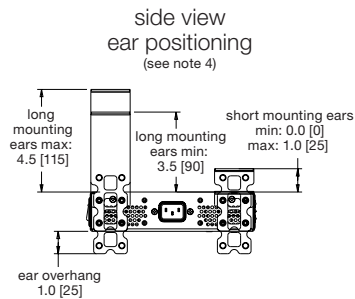
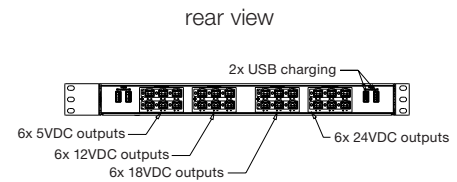
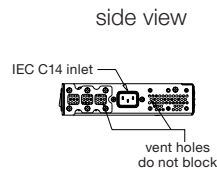
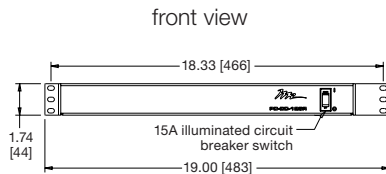
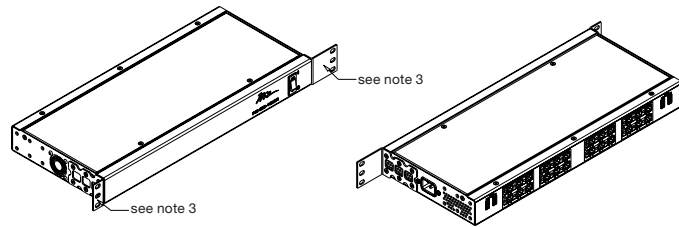
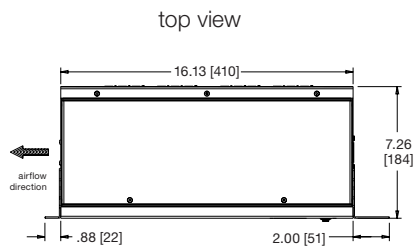

- Notes:
1. Thermostatically controlled fan for cooling. Do not block fan or vent holes. Maximum sound level: 28 DBA @ 1 meter
  2. PD-DC-125R comes preinstalled with short mounting ears as shown.
  3. Ear positioning may be changed from front to back, offset, or rotated 90 degrees. Long ears are also included. See ear positioning views for dimensional details.

all dimensions in inches unless otherwise noted [all dimensions in brackets are in millimeters]

Specification	Details
Line Voltage	120VAC/60Hz (Min. 100Vac, Max. 132VAC)
Current Rating	5A AC
Maximum Power Rating	600W (DC Outputs Fully Loaded)
AC Input Connector	IEC C-14
Power Cord Length	6 Feet
Surge Protection	MOV, Mode L-N, Clamping Voltage 595V
Total DC Output Current	11.2A
Total DC Output Power	125.3W
DC Output Over Current Protection	Automatically Resetting PTC Fuse on Each Output
Idle Current	.250A AC

DC Outputs			
Voltage	Max Current Total (Rail)	Max Current Per Output	Rail Current Warning
5V DC	3A	2A	2.85A
12V DC	2A	1.5A	1.9A
18V DC	2.5A	1A	2.25A
24V DC	1.2A	0.75A	1.15A
USB 5V DC	2.5A	2.1A	N/A

Caution! Do Not Exceed Maximum Ratings