





: `ccf`GhUbX]b[`7 UV]bYhCdH]cbg

  Spec. # 96-936 for full product info. 





BS-MRK-31

Inner Platform Base [for MRK and WRK Series Racks]

Provides a handy platform, flush with bottom rackspace, for supporting heavy equipment and mounting electrical boxes. Fits inside rack.

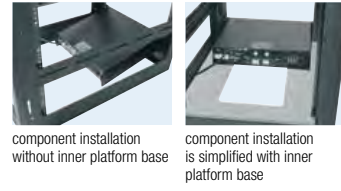
Part #	Fits
BS-WRK-27	WRK 27" deep
BS-WRK-32	WRK 32" deep
BS-MRK-26	MRK 26" deep
BS-MRK-31	MRK 31" deep
BS-MRK-36	MRK 36" deep
BS-MRK-42	MRK 42" deep

5W set of 4 commercial grade casters

5WL set of 4 commercial locking grade casters



5WR set of 4 fine floor casters

5WLR set of 4 locking fine floor casters

Swivel Casters [for ERK and Slim 5 Series Racks]

Bolt to bottom of all ERK & Slim 5 series rack systems. Adds 3-7/8" to overall height.

- Commercial grade casters**
- 1,300 lb. weight capacity
- Fine floor casters**
- 700 lb. weight capacity
 - Constructed from synthetic rubber to protect fine flooring!

  Spec. # 96-936 for full product info. 



CBS-ERK-20R

Skirted Caster Bases [for ERK and Slim 5 Series Racks]

Skirted base hides wheels for an improved aesthetic appearance, and bolt to bottom of ERK and Slim 5 Series rack systems. Skirted caster bases add 3-3/4" to overall rack height Each base comes with its wheels pre-installed.

- Commercial grade casters**
- Heavy duty non-locking 3" swivel wheels
 - UL Listed in the US and Canada
- Fine floor casters**
- 700 lb. weight capacity
 - Constructed from synthetic rubber to protect fine flooring!

Commercial Grade Caster Base Part #	Fine Floor Caster Base Part #	Fits
CBS-ERK-20	CBS-ERK-20R	ERK 20" deep
CBS-ERK-25	CBS-ERK-25R	ERK 25" deep
CBS-5	CBS-5R	Sim 5 20" deep
CBS-5-26	CBS-5-26R	Slim 5 26" deep

  Spec. # 96-936 for full product info. 



CBS-MRK-31

Recessed Caster Bases [for MRK, WRK and DRK Series Racks]

Recessed caster bases fit inside the rack and only increase the overall rack height by 15/16". Recessed Caster bases work with LF leveling feet, see pg. 31. Each base comes with its wheels pre-installed.

- Commercial grade casters**
- Heavy duty non-locking 3" swivel wheels
 - 1,300 lb. weight capacity
 - UL Listed in the US and Canada
- Fine floor casters**
- 700 lb. weight capacity
 - Constructed from synthetic rubber to protect fine flooring!

Commercial Grade Caster Base Part #	Fine Floor Caster Base Part #	Fits
CBS-WRK-27	CBS-WRK-27R	WRK 27" deep
CBS-WRK-32	CBS-WRK-32R	WRK 32" deep
CBS-MRK-26	CBS-MRK-26R	MRK 26" deep
CBS-MRK-31	CBS-MRK-31R	MRK 31" deep
CBS-MRK-36	CBS-MRK-36R	MRK 36" deep
CBS-DRK-31	-	DRK 31" deep
CBS-DRK-36	-	DRK 36" deep

Enclosure Options

Seismic Floor Anchor Brackets

When properly installed, seismic floor anchor brackets bring any Seismic Certified DRK, WRK, MRK, VMRK, VRK, ERK, SC, SCQ, SCRK, SCQRK and WMRK Series enclosure to applicable Zone 4, Seismic Design Category (SDC) "D" and Seismic Use Group III Upper Floor Essential Equipment rating and have an Ip rating of 1.5. Includes four brackets.

Part #	Fits
WRK-Z4	WRK Series
MRK-Z4	MRK, DRK, VMRK Series
VRK-Z4	VRK Series
ERK-Z4	ERK Series
SC-Z4	SC, SCQ, SCRK, SCQRK Series
WMRK-Z4	WMRK Series

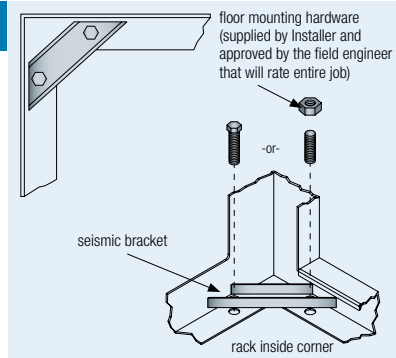

Leveling Feet

Adjustable leveling feet fit Middle Atlantic Products floor standing steel racks and enclosures (excludes VRK Series). Isolation Leveling Feet feature protective rubber cover to isolate racks from the floor. Flat-blade and hex drive allows for adjustment. Also can be used in conjunction with recessed caster bases for MRK, WRK & DRK Series racks. Set of four. NOTE: Raises enclosure from 1/8" to 1" off floor.

Part #	Description
LF	leveling feet
LF-ISO	isolation leveling feet
LF-WMRK	WMRK isolation leveling feet

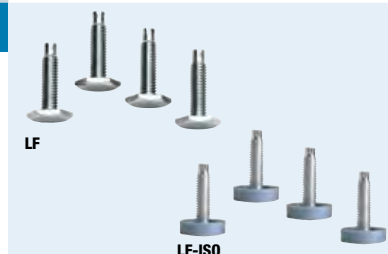

Ganging Hardware

Time-saving ganging hardware provides easy field alignment and joining of multi-bay enclosures. Available hardware includes drift pins, 1/2" magnetized sockets and enough 5/16" flange nuts and bolts to gang up to 10 racks or consoles.

Part #	Description
DRIFT	set of two tapered drift pins
MAG-1/2	set of two 1/2" magnetic sockets
GANG-10	5/16" nuts/bolts to gang 10 racks or consoles
GANG-10T	5/16" bolts for ganging BGR via threaded inserts

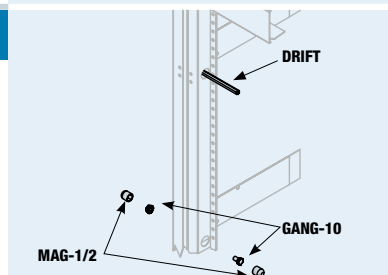

Side Panels

The new sides (37 spaces and above) are horizontally split with an easier to manage interlocking design. Same user-installed keylock option for additional security if desired – as is the standard on all our universal side panels. NOTE: Each side panel adds 5/8" to width of rack.

Part #	Description	Fits	Part #	Description	Fits
SPN-24-267	2 full-height panels	fits racks 24 space & 26" or 27" deep	SPN-42-48	4 half-height panels	fits racks 42 space & 48" deep
SPN-24-312	2 full-height panels	fits racks 24 space & 31" or 32" deep	SPN-44-267	4 half-height panels	fits racks 44 space & 26" or 27" deep
SPN-24-36	2 full-height panels	fits racks 24 space & 36" deep	SPN-44-312	4 half-height panels	fits racks 44 space & 31" or 32" deep
SPN-37-267	4 half-height panels	fits racks 37 space & 26" or 27" deep	SPN-44-36	4 half-height panels	fits racks 44 space & 36" deep
SPN-37-312	4 half-height panels	fits racks 37 space & 31" or 32" deep	SPN-44-423	4 half-height panels	fits racks 44 space & 42" or 43" deep
SPN-40-267	4 half-height panels	fits racks 40 space & 26" or 27" deep	SPN-45-36	4 half-height panels	fits racks 45 space & 36" deep
SPN-40-312	4 half-height panels	fits racks 40 space & 31" or 32" deep	SPN-45-42	4 half-height panels	fits racks 45 space & 42" deep
SPN-42-36	4 half-height panels	fits racks 42 space & 36" deep	SPN-45-48	4 half-height panels	fits racks 45 space & 48" deep
SPN-42-42	4 half-height panels	fits racks 42 space & 42" deep	SPN-54-312	4 half-height panels	fits racks 54 space & 31" deep

