

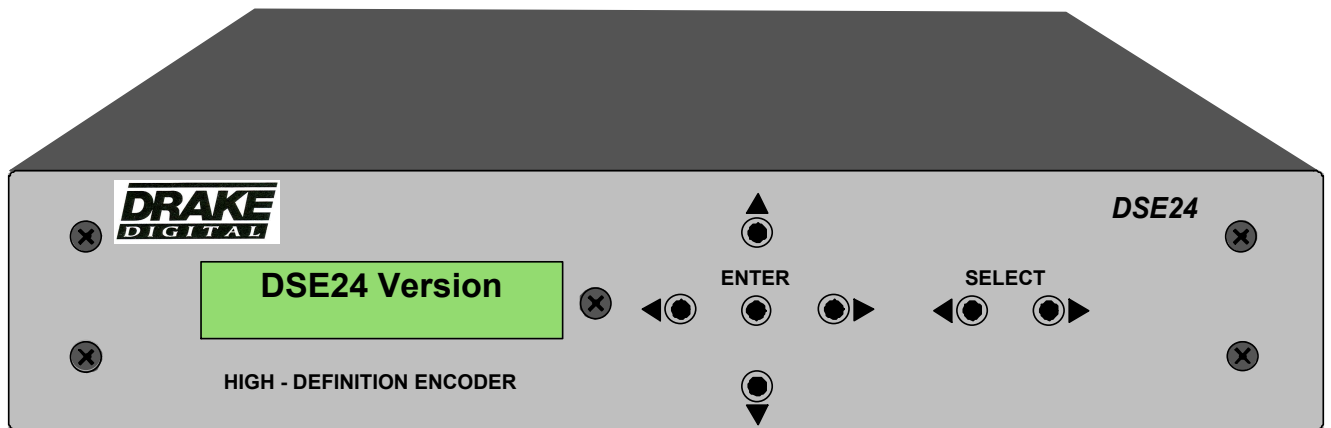

DSE24 High Definition Encoder

Instruction Manual



DRAKE™ is a registered trademark of the R.L. Drake LLC

2 Caution Statements & Table of Contents

WARNING: TO PREVENT FIRE OR ELECTRICAL SHOCK DO NOT EXPOSE TO RAIN OR MOISTURE

	CAUTION RISK OF ELECTRIC SHOCK DO NOT OPEN	
CAUTION: TO REDUCE THE RISK OF ELECTRIC SHOCK, DO NOT REMOVE COVER NO USER-SERVICEABLE PARTS INSIDE REFER SERVICING TO QUALIFIED PERSONNEL		



A product and cart combination should be moved with care. Quick stops, excessive force and uneven surfaces may cause the product and cart combination to overturn.

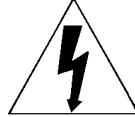

The lightning flash with arrow head symbol, within an equilateral triangle, is intended to alert the user to the presence of uninsulated "dangerous voltage" within the product's enclosure that may be of sufficient magnitude to constitute a risk of electric shock to persons.



The exclamation point within an equilateral triangle is intended to alert the user to the presence of important operating and maintenance (servicing) instructions in the literature accompanying the product.

WARNING: TO REDUCE THE RISK OF FIRE OR ELECTRIC SHOCK, DO NOT EXPOSE THIS PRODUCT TO RAIN OR MOISTURE.
DO NOT OPEN THE CABINET, REFER SERVICING TO QUALIFIED PERSONNEL ONLY.

CAUTION: TO PREVENT ELECTRIC SHOCK, DO NOT USE THIS (POLARIZED) PLUG WITH AN EXTENSION CORD RECEPTACLE OR OTHER OUTLET UNLESS THE BLADES CAN BE FULLY INSERTED TO PREVENT BLADE EXPOSURE.

ATTENTION: POUR PREVENIR LES CHOCS ELECTRIQUES, NE PAS UTILISER CETTE FICHE POLARISEE AVEC UN PROLONGATEUR, UNE PRISE DE COURANT OU UNE AUTRE SORTIE DE COURANT, SAUF SI LES LAMES PEUVENT ETRE INSEREES A FOND SANS EN LAISSER AUCUNE PARTIE A DECOUVERT.

TABLE OF CONTENTS

2	Caution Statements & Table of Contents	11	Setup and Programming (continued)
3	Important Safety Instructions	12	Operating Instructions (From the Front Panel)
4	Important Safety Instructions (cont)	13	Operating Instructions (From a PC)
5	Specifications	14	Additional Information
6	General Description	15	CATV Channel Frequencies
7	Installation and Mounting / Front Panel Controls	16	Broadcast TV & T Channel Frequencies
8	Rear Panel Connections	17	Service / If You Need To Call For Help
9	Software Flow Chart	18	Warranty
10	Setup and Programming		

Important Safety Instructions 3

Consignes importantes de sécurité 3

1. Read Instructions—All the safety and operating Instructions should be read before the product is operated.

1a. Lire les directives - Toutes les directives de sécurité et d'utilisation devraient être lues avant de mettre l'appareil en opération.

2. Retain Instructions—The safety and operating instructions should be retained for future reference.

2a. Conserver les directives - Les directives de sécurité et d'utilisation devraient être conservées pour consultation future.

3. Heed Warnings—All warnings on the product and in the operating instructions should be adhered to.

3a. Tenir compte des avertissements - Tous les avertissements apparaissant sur l'appareil et dans les consignes d'utilisation devraient être respectés.

4. Follow instructions - All operating and use instructions should be followed.

4a. Suivre les directives - Toutes les directives d'opération et d'utilisation devraient être suivies.

5. Cleaning—Unplug this product from the wall outlet before cleaning. Do not use liquid cleaners or aerosol cleansers. Use a damp cloth for cleaning.

5a. Nettoyage - Débrancher l'appareil de la prise électrique murale avant le nettoyage. Ne pas utiliser de nettoyants liquides ou aérosols. Employer un linge humide pour le nettoyage.

6. Attachments—Do not use attachments that are not recommended by the product manufacturer as they may cause hazards.

6a. Fixation - Ne pas utiliser d'autres fixations que celles recommandées par le fabricant; elles pourraient être source de dangers.

7. Water and Moisture—Do not use this product near water—for example, near a bathtub, wash bowl, kitchen sink or laundry tub; in a wet basement; or near a swimming pool; and the like.

7a. Eau et humidité - Ne pas utiliser cet appareil près de l'eau. Par exemple, près d'une baignoire, d'un bac de lavage, d'un évier de cuisine ou d'une cuvette de lessivage; dans un sous-sol humide; ou à proximité d'une piscine; et autres environnements similaires.

8. Accessories—Do not place this product on an unstable cart, stand, tripod, bracket, or table. The product may fall, causing serious injury to a child or adult and serious damage to the product. Use only with a cart, stand, tripod, bracket, or table recommended by the manufacturer, or sold with the product. Any mounting of the product should follow the manufacturer's instructions, and should use a mounting accessory recommended by the manufacturer.

8a. Accessoires - Ne pas installer cet appareil sur un chariot, un socle, un trépied, un support ou une table instables. L'appareil pourrait tomber, entraînant des blessures graves à un enfant ou à un adulte, et des dommages importants à l'appareil. Employer seulement avec un chariot, un socle, un trépied, un support, ou une table recommandés par le fabricant ou vendu avec l'appareil. Toute installation de l'appareil devrait être conforme aux directives du fabricant et devrait utiliser des accessoires d'installation recommandés par celui-ci.

9. A product and cart combination should be moved with care. Quick stops, excessive force, and uneven surfaces may cause the product and cart combination to overturn.

9a. Un chariot supportant l'appareil devrait être déplacé avec précaution. Les arrêts brusques, la force excessive et les surfaces inégales peuvent renverser le chariot.

10. Ventilation—Slots and openings in the cabinet are provided for ventilation and to ensure reliable operation of the product and to protect it from overheating, and these openings must not be blocked or covered. The openings should never be blocked by placing the product on a bed, sofa, rug, or similar surface. This product should not be placed in a built-in installation such as bookcase or rack unless proper ventilation is provided or the manufacturer's instructions have been adhered to.

10a. Ventilation - Des fentes et ouvertures dans le châssis sont prévues pour la ventilation de l'appareil, pour en assurer la fiabilité d'opération et le protéger contre la surchauffe. Ces ouvertures ne doivent pas être bloquées ou recouvertes. Ces ouvertures ne devraient jamais être bloquées en plaçant l'appareil sur un lit, un sofa, une couverture, ou une surface semblable. Cet appareil ne devrait pas être installé dans un meuble encastré comme une bibliothèque ou une étagère à moins de lui fournir une ventilation adéquate ou que l'installation soit conforme aux directives du fabricant.

11. Power Sources—This product should be operated only from the type of power source indicated on the marking label. If you are not sure of the type of power supplied to your home, consult your product dealer or local power company. For products intended to operate from battery power, or other sources, refer to the operating instructions.

11a. Sources d'alimentation électrique - Cet appareil devrait être utilisé seulement avec le type d'alimentation électrique inscrite sur l'étiquette. Si vous n'êtes pas certain du type d'alimentation électrique fourni à votre maison, consultez le vendeur de l'appareil ou l'entreprises d'énergie locale. Pour des appareils alimentés par une batterie ou d'autres sources, se référer aux consignes d'utilisation.

12. Grounding or Polarization—This product may be equipped with a polarized alternating-current line plug (a plug having one blade wider than the other) This plug will fit into the power outlet only one way. This is a safety feature. If you are unable to insert the plug fully into the outlet, try reversing the plug. If the plug should still fail to fit, contact your electrician to replace your obsolete outlet. Do not defeat the safety purpose of the polarized plug.

Alternate Warnings—If this product is equipped with a three-wire grounding-type plug, a plug having a third (grounding) pin, the plug will only fit into a grounding-type power outlet. This is a safety feature. If you are unable to insert the plug into the outlet, contact your electrician to replace your obsolete outlet. Do not defeat the safety purpose of the grounding-type plug.

12a. Mise à la terre ou polarisation - Cet appareil peut être équipé d'une fiche électrique de courant alternatif polarisée (une fiche ayant une lame plus large que l'autre). Cette fiche ne s'insérera correctement dans la prise de courant que d'une seule façon; c'est un dispositif de sécurité. S'il est impossible d'insérer la fiche entièrement dans la prise de courant, essayer de renverser la fiche. Si la fiche ne s'insère toujours pas, contacter un électricien pour remplacer la prise de courant désuète. Ne pas altérer le dispositif de sécurité de la fiche polarisée. **Mise en garde supplémentaire** - Si cet appareil est équipé d'une fiche électrique à trois broches (une fiche ayant une broche de mise à la terre), la fiche s'insérera seulement dans une prise de courant équipée d'une mise à la terre; c'est un dispositif de sécurité. S'il est impossible d'insérer la fiche dans la prise de courant, contacter un électricien pour remplacer la prise de courant désuète. Ne pas altérer le dispositif de sécurité de la fiche avec mise à la terre.

13. Power-Cord Protection—Power-supply cords should be routed so that they are not likely to be walked on or pinched by items placed upon or against them, paying particular attention to cords at plugs, convenience receptacles, and the point where they exit from the product.

13a. Protection du cordon d'alimentation - Les cordons d'alimentation devraient être disposés de façon à ce qu'on ne puisse marcher dessus ou qu'ils soient susceptibles d'être coincés par des articles placés sur ou contre eux. Une attention particulière doit être portée aux fiches, prises de courant, et aux points où ils sortent de l'appareil.

14. Outdoor Antenna Grounding—If an outside antenna or cable system is connected to the product, be sure the antenna or cable system is grounded so as to provide some protection against voltage surges and built-up static charges. Article 810 of the National Electrical Code, ANSI/NFPA 70, provides information with regard to proper grounding of the mast and supporting structure, grounding of the lead-in wire to an antenna discharge unit, size of grounding conductors, location of antenna-discharge unit, connection to grounding electrodes, and requirements for the grounding electrode. See Figure A.

14a. Mise à la terre de l'antenne extérieure - Si un système extérieur d'antenne ou de câble est relié à l'appareil, s'assurer que le système d'antenne ou de câble est muni d'une mise à la terre afin de fournir une certaine protection contre les surtensions et les charges d'électricité statique. L'article 810 du code électrique national, ANSI/NFPA 70, fournit l'information nécessaire en ce qui concerne la mise à la terre appropriée du mât et de la structure porteuse, la mise à la terre du câble de connexion à une unité de décharge d'antenne, le calibre des conducteurs de mise à la terre, la location de l'unité de décharge d'antenne, le raccordement aux électrodes de mise à la terre et les spécifications pour les électrodes de mise à la terre.

Voir la figure A.

15. Lightning—For added protection for this product during a lightning storm, or when it is left unattended and unused for long periods of time, unplug it from the wall outlet and disconnect the antenna or cable system. This will prevent damage to the product due to lightning and power-line surges.

15a. Foudre - Pour une protection supplémentaire de cet appareil pendant un orage électrique, ou quand il est laissé sans surveillance et inutilisé pendant de longues périodes, le débrancher de la prise électrique murale et déconnecter le système d'antenne ou de câble. Ceci prévient les dommages à l'appareil dus à la foudre et aux surtensions.

16. Power Lines—An outside antenna system should not be located in the vicinity of overhead power lines, other electric light or power circuits, where it can fall into such power lines or circuits. When installing an outside antenna system, extreme care should be taken to keep from touching such power lines or circuits as contact with them may be fatal.

16a. Lignes électriques - Un système d'antenne extérieure ne devrait pas être situé à proximité de lignes électriques aériennes ou de tout autre circuit électrique, où il pourrait tomber sur de tels circuits ou lignes électriques. Lors de l'installation d'un système d'antenne extérieure, d'extrêmes précautions devraient être prises afin de prévenir tout contact avec des lignes ou circuits électriques. Entrer en contact avec de tels circuits ou lignes électriques pourrait être fatal.

17. Overloading—Do not overload wall outlets, extension cords, or integral convenience receptacles as this can result in a risk of fire or electric shock.

17a. Surcharge - Ne pas surcharger les prises de courant murales, les rallonges électriques ou les prises de courant intégrées. Un risque d'incendie ou de choc électrique pourrait résulter d'une telle surcharge.

4 Important Safety Instructions (cont.)

4 Consignes importantes de sécurité

18. Object and Liquid Entry—Never push objects of any kind into this product through openings as they may touch dangerous voltage points or short-out parts that could result in a fire or electric shock. Never spill liquid of any kind on the product.

18a. Insertion d'objet ou de liquide – Ne jamais insérer d'objet par les ouvertures de cet appareil. Il pourrait toucher des points de voltage dangereux ou court-circuiter des pièces, ce qui pourrait résulter en incendie ou en choc électrique. Ne jamais verser de liquide sur l'appareil.

19. Servicing—Do not attempt to service this product yourself as opening or removing covers may expose you to dangerous voltage or other hazards. Refer all servicing to qualified service personnel.

19a. Entretien – Ne pas essayer de faire soi-même l'entretien de cet appareil. En ouvrir ou en retirer les couvercles pourrait vous exposer à des voltages dangereux ou à d'autres dangers. Confier tout entretien à un personnel de service qualifié.

20. Damage Requiring Service—Unplug this product from the wall outlet and refer servicing to qualified service personnel under the following conditions:

- a. When the power-supply cord or plug is damaged,
- b. If liquid has been spilled, or objects have fallen into the product,
- c. If the product has been exposed to rain or water,
- d. If the product does not operate normally by following the operating instructions. Adjust only those controls that are covered by the operating instructions as an improper adjustment of other controls may result in damage and will often require extensive work by a qualified technician to restore the product to its normal operation,
- e. If the product has been dropped or damaged in anyway, and
- f. When the product exhibits a distinct change in performance—this indicates a need for service.

20a. Dommages exigeant un entretien – Débrancher cet appareil de la prise de courant électrique et confier l'entretien au personnel de service qualifié dans les éventualités suivantes:

- a. Quand le cordon d'alimentation ou sa fiche sont endommagés,
- b. Si des objets sont tombés dans l'appareil, ou si du liquide y a été renversé,
- c. Si l'appareil a été exposé à la pluie ou à l'eau,
- d. Si l'appareil ne fonctionne pas normalement en suivant les consignes d'utilisation.

Ajuster seulement les commandes qui sont mentionnées dans le guide d'opération. Un mauvais ajustement des autres commandes pourrait causer des dommages à l'appareil et souvent exiger un travail supplémentaire de la part d'un technicien qualifié pour remettre l'appareil en état normal d'opération.

e. Si l'appareil a été échappé ou endommagé de n'importe quelle façon, et **f.** Quand l'appareil montre un changement notable de performance – ceci indique qu'un entretien est nécessaire.

21. Replacement Parts—When replacement parts are required, be sure the service technician has used replacement parts specified by the manufacturer or have the same characteristics as the original part. Unauthorized substitutes may result in fire, electric shock or other hazards.

21a. Pièces de rechange - Si des pièces de rechange sont nécessaires, s'assurer que le technicien de service a employé des pièces de rechange spécifiques du manufacturier ou ayant les mêmes caractéristiques que les pièces originales. L'utilisation de pièces de rechange non autorisées pourrait résulter en incendie, choc électrique ou autres dangers.

22. Safety Check—Upon completion of any service or repairs to this product, ask the service technician to perform safety checks to determine that the product is in proper operating condition.

22a. Vérification de sécurité – À la suite de toute réparation ou entretien de cet appareil, demander au technicien de service d'exécuter des vérifications de sécurité afin de s'assurer que l'appareil est en condition normale de fonctionnement.

23. Wall or Ceiling Mounting—The product should be mounted to a wall or ceiling only as recommended by the manufacturer.

23a. Montage au mur ou au plafond - L'appareil ne devrait être monté au mur ou au plafond qu'uniquement de la façon recommandée par le manufacturier.

24. Heat—The product should be situated away from heat sources such as radiators, heat registers, stoves, or other products (including amplifiers) that produce heat.

24a. Chaleur – L'appareil devrait être situé loin de sources de chaleur telles que des radiateurs, des registres de chaleur, des fourneaux, ou d'autres appareils (y compris amplificateurs) produisant de la chaleur.

Figure A

Example of antenna grounding as per National Electrical Code, ANSI/NFPA 70

Exemple de mise à la terre d'antenne selon le code électrique national, ANSI/NFPA 70

NOTE TO CATV SYSTEM INSTALLERS:

THIS REMINDER IS PROVIDED TO CALL THE CATV SYSTEM INSTALLER'S ATTENTION TO ARTICLE 820 - 40 OF THE NEC THAT PROVIDES GUIDELINES FOR PROPER GROUNDING AND, IN PARTICULAR, SPECIFIES THAT THE CABLE GROUND SHALL BE CONNECTED TO THE GROUNDING SYSTEM OF THE BUILDING, AS CLOSE TO THE POINT OF CABLE ENTRY AS PRACTICAL.

NOTE AUX INSTALLATEURS DE SYSTÈME DE CATV :

CE RAPPEL EST FOURNI POUR PORTER À L'ATTENTION DES INSTALLATEURS DE SYSTÈME DE CATV, L'ARTICLE 820 - 40 DU NEC QUI DONNE DES DIRECTIVES POUR UNE MISE À LA TERRE APPROPRIÉE ET, EN PARTICULIER, SPÉCIFIE QUE LE CÂBLE DE MISE À LA TERRE DEVRAIT ÊTRE RACCORDÉ AU SYSTÈME DE MISE À LA TERRE DU BÂTIMENT LE PLUS PRÈS POSSIBLE DE L'ENTRÉE DU CÂBLE.

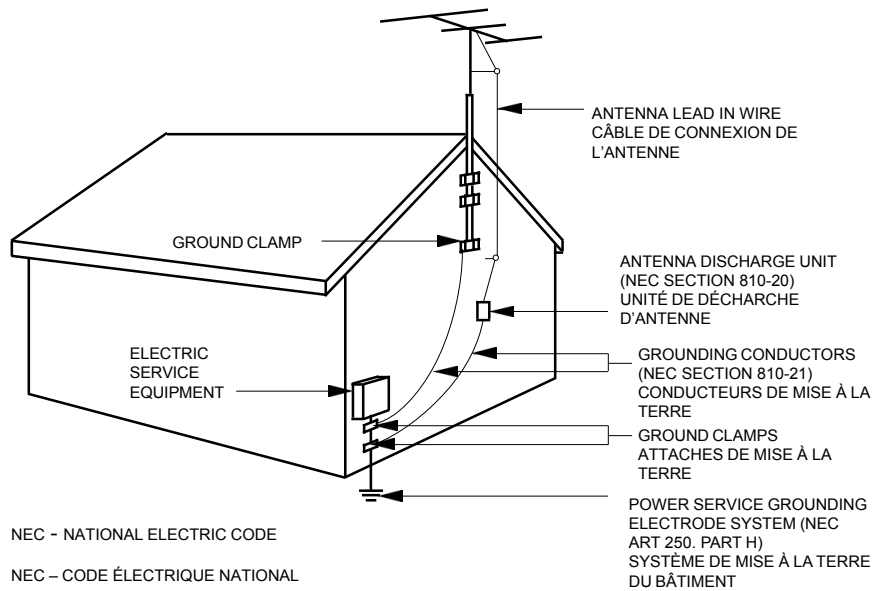

NEC - NATIONAL ELECTRIC CODE

NEC - CODE ÉLECTRIQUE NATIONAL

SPECIFICATIONS
DSE24 High Definition Encoder

Video Inputs: VGA (with pass-through to monitor)
HDMI (unencrypted)
Component (Y-Cr-Cb)
Composite via Y input for 480i

Input Resolutions: 480i, 480p, 720p, 1080i video

Audio Inputs: L-R baseband audio, dual RCA
S/PDIF optical audio, 32kHz-192kHz sample rate PCM
HDMI embedded audio, 32kHz-192kHz sample rate PCM

Video Encoding: MPEG2
Resolutions: 720x480, 1280x720, 1920x1080 - determined by input.
Color Sampling: 4:2:2.
Aspect Ratio: Determined by input.
GOP: User adjustable from 1 - 30.

Audio Encoding: MPEG1, Layer 2 (MP2)

QAM Output: 64QAM or 256QAM, ITU Annex B
Frequency Coverage: 5 - 1000 MHz
Channel Plans: STD, HRC, IRC, Broadcast and T Channels.
Output Power: +45 dBmV
Output Level Adjustment Range: 15 dB
Phase Noise: -95 dBc / Hz @ 10 kHz offset
Broadband noise: -75 dBc @ > ±12 MHz offset, 4 MHz BW.
MER: >40 dB equalized
Channel Frequency response: < 1 dB
Carrier Suppression: >40dB
I/Q imbalance: < 1 degree
Output Level Accuracy: ±1 dB
Spurious: > -60 dBc;
Second Harmonic in the T-Channel band > -55 dBc

Format: Table-top chassis, with optional 2-unit mounting in 1 RU
19" rack.

Control: Front-panel buttons and LCD for local control.
On-board ethernet connection for remote control.

Power: +5V from supplied power supply.

6 General Description

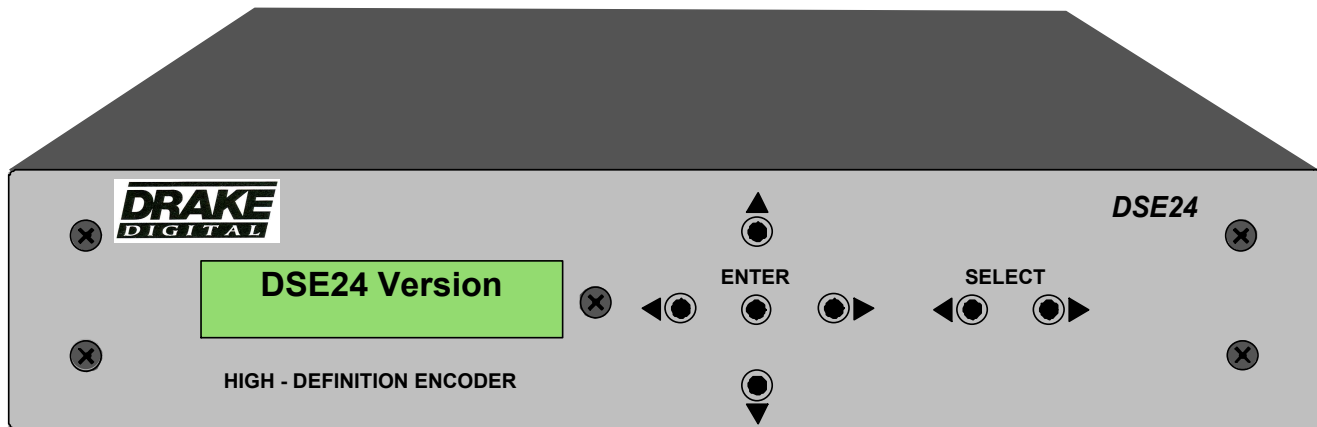

GENERAL DESCRIPTION

The Drake model DSE24 is a High Definition or Standard Definition MPEG2 video and audio encoder combined with a QAM modulator and RF up-converter. The DSE24 is particularly well suited for digital signage applications, allowing transmission to the monitor via regular coaxial cable infrastructure. Multiple DSE24s can provide multiple programs that can be distributed on the same coax.

The DSE24 is housed in a convenient table top package. Using the optional 19" rack mounting panel, one or two DSE24s can be rack mounted in just 1RU of height.

The DSE24 accepts analog high definition or standard definition video input via component, VGA, or composite inputs. Digital video can also be input via a HDMI (without HDCP) input. Audio can be input via imbedded HDMI audio, S/PDIF optical digital input, or analog left and right RCA jacks.

Video is encoded using MPEG2 encoding. Audio is encoded using MPEG1, Layer 2 encoding. The QAM RF output can be either 64QAM or 256QAM, both annex B mode. The built-in up-converter RF output is agile and can output on any 6 MHz broadcast or CATV channel between 54 and 1000 MHz and additionally on T channels T7 through T14 (channel center frequencies 8.75 through 50.75 MHz respectively).

INSTALLATION AND MOUNTING NOTES

This equipment is designed to be installed either as a table top unit or with an optional standard 1RU 19" rack panel. When the unit is mounted above or below other rack mounted equipment, a 1U space (1.75") should be left between the unit and the other equipment to allow ambient air flow between the units. No space is needed between DSE24 units themselves.

Connect the external power supply to an appropriate source of 120 volt, 50/60 Hz AC power, and connect the power supply output to the rear panel DC power jack. The DSE24 is always on once the AC power cord is connected to its power source.

FRONT PANEL CONTROLS

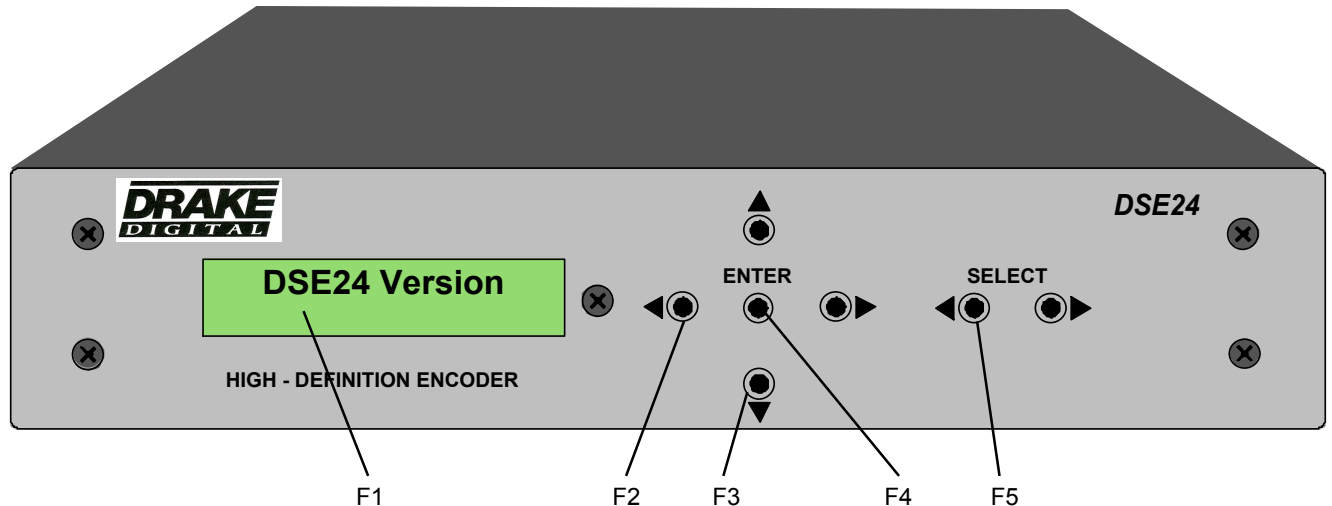

F1, LCD Display - This display presents the selected menu screen and the parameter settings as well as various status and error messages. The backlight in the display is on when power is applied.

F2, ◀ Left and ▶ Right Buttons – Use the left and right arrow buttons to navigate from screen to screen to view the various parameter settings.. These buttons are operational in either the view mode or the program mode. Using only these buttons will not change any parameter setting.

F3, ▲ Up and ▼ Down Buttons – Use the up and down arrow buttons to change the value of a viewed parameter setting. The unit must be in the program mode in order for these buttons to become active for changing a parameter setting. If the unit is not in the program mode, repeatedly pressing the ▲ Up button will toggle between the version number of the DSE24 firmware and the video and audio

status. Pressing the ▼ Down button will show the video and audio status. If the video and audio status are already displayed, pressing the ▼ Down button will have no effect.

F4, ENTER Button - Use the ENTER button to enter the program mode or to save and load a new setting or settings after adjustment. Hold for approximately 2 seconds until the bottom line of the display starts to flash to enter the program mode. After entering the program mode, momentarily pressing the ENTER button again will load and save any settings that may have been changed using the Up and Down buttons.

F5, ◀ Left and ▶ Right SELECT Buttons - Use the Left and Right SELECT buttons to move the flashing cursor left or right when entering information in the CHANNEL NAME, USER NAME, PASSWORD, HOST NAME, MAC ADDRESS, IP ADDRESS, SUBNET MASK and GATEWAY ADDRESS menu items. The selection of the alphanumeric character for each cursor position can then be made using the UP and DOWN (F3) buttons.

8 Rear Panel Connections

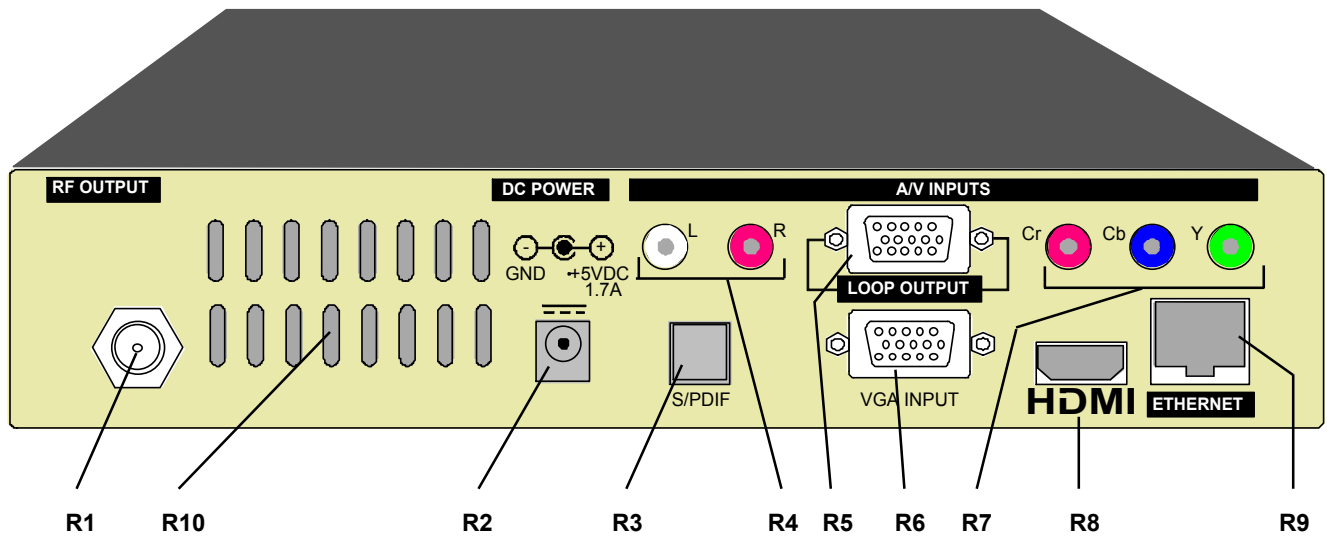

REAR PANEL CONNECTIONS

R1, RF OUTPUT – This type "F" connector is the high level (+29.5 dBmV to +45 dBmV), 5 to 1002 MHz, output from the DSE24 RF output section.

R2, DC POWER CONNECTOR - This connector provides the means for connection to the 5 VDC output of the supplied external power supply.

R3, S/PDIF - This optical connector provides an input for optically encoded S/PDIF audio.

R4, AUDIO 1 & 2 - These two color coded RCA type connectors provide baseband audio **Left** (white) and **Right** (red) inputs to the DSE24 Encoder.

R5, VGA LOOP OUTPUT - This connector provides VGA video output to a monitor or other equipment requiring VGA input. It is only active when VGA is input on R6.

R6, VGA INPUT - This VGA type connector provides the means to input VGA video from a computer or other device with VGA output.

R7, COMPONENT VIDEO - These three color coded RCA connectors, **Cr** (red), **Cb** (blue), and **Y** (green), provide the means to input component video. To input composite video, use the green 'Y' connector.

R8, HDMI Connector - This connector provides the means to input HDMI video (without HDCP) and encoded audio.

R9, ETHERNET Connector - This connector provides the means to connect the DSE24 to an Ethernet local area network for remote control, monitoring, and/or firmware update. It is not recommended that this port be connected directly to a wide-area network without external access controls, like a VPN or firewall.

R10, Cooling Air Vents. Do not block.

DSE24 HIGH DEFINITION ENCODER SOFTWARE FLOW CHART

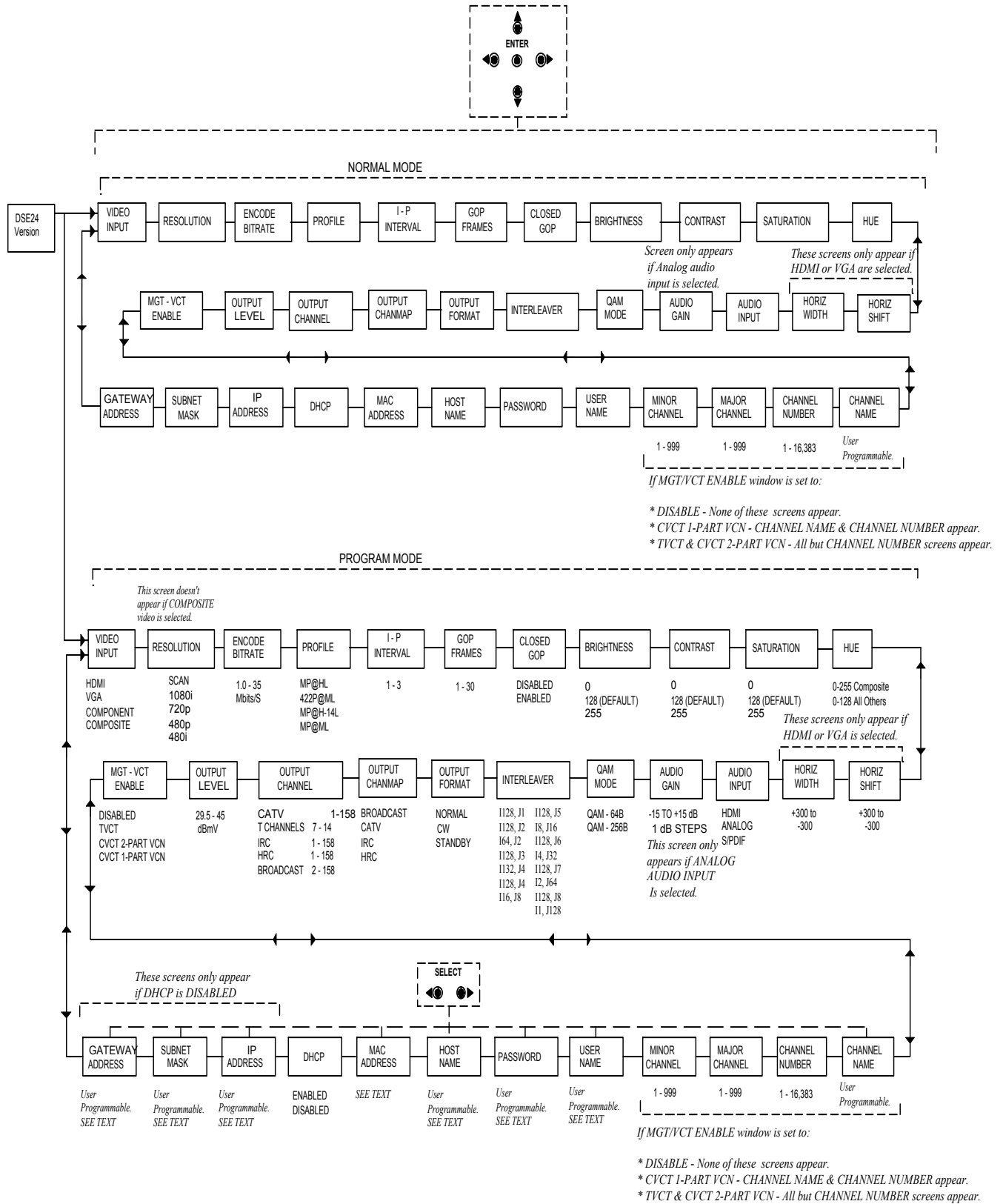

10 Setup and Programming

Programming and viewing of the various setup and operating parameters is accomplished using the front panel backlit, two line, sixteen character wide LCD along with the two LEFT and RIGHT 'SELECT' buttons and the five LEFT, RIGHT, UP, DOWN and ENTER buttons. The name of the parameter is on the top line of the display and the setting value is on the bottom line.

To observe a certain parameter setting without intending to change its value, just use the LEFT and RIGHT arrow buttons to navigate through the menus shown in the software flow chart on the previous page. The current setting for each parameter is shown on the bottom line of the display. Note that depending upon certain settings, some screens are not needed and will be skipped.

To make a change in the displayed parameter and its setting and if this is the initial setup, you will want to enter the 'program' mode. To do this, press the ENTER button that is located in the center of the four arrow buttons and hold in for several seconds until the bottom line of the display begins to flash.

After you are in the program mode (bottom line of screen flashing) use the LEFT and RIGHT arrows to navigate among screens and use the UP and DOWN arrows to change the parameter setting. When ENTER is pressed, the new settings will be loaded and stored and the unit will exit the 'program' mode. You may wish to not press ENTER until you have gone through all screens and settings and then press ENTER to save and load all changes in one step, OR you can store just one or several parameters at a time and reenter program mode to set the next. Either method is acceptable.

When programming a menu item that requires an alphanumeric entry, use the SELECT LEFT and RIGHT buttons to move the cursor to the desired location and use the UP and DOWN buttons to scroll through the list of alphanumerics until the desired character appears.

Note that the SELECT buttons will have no effect in normal mode or in program mode if the selected menu item requires no alphanumeric.

This section provides additional details regarding the selectable items shown in the 'program' mode on the Software Flow Chart on page 9.

VIDEO INPUT: This menu item provides the means to select the format type of video to be encoded. The choices are HDMI, VGA, Component and Composite. Appropriate input connectors for each of these video formats are provided on the rear panel. For Composite video input, use the 'Y' (green) connector.

RESOLUTION: The resolution of the video output may be selected from this menu item. The choices are SCAN, 720p, 1080i, 480i and 480p as shown on the software flow chart on page 9. The RESOLUTION screen will not appear if composite video is selected. If SCAN is selected, the unit will scan through the available resolution choices until it finds the one which matches the video input. Also note that 480i will not be available if VGA video input is selected.

ENCODE BITRATE: This menu item allows the user to select the encode bitrate. The choices are from 1.0 to 25 Mbits per second in .1 Mbit/S steps if QAM64B is selected, and 1 - 35 Mbits per second in .1 Mbit/S steps if QAM256B is selected.

PROFILE: The user may select the profile to be used to encode the program material. The choices are MP@HL (Main Profile@ High Level), 422P@ML, MP@H-14L, and MP@ML.

I - P INTERVAL: This menu item allows the user to select the I - P interval. The choices are 1, 2 or 3.

GOP FRAMES: This menu item allows the user to select the number of frames within a GOP (Group Of Pictures). The choices are from 1 to 30 in steps of 1.

CLOSED GOP: This menu item allows the user to select whether or not a Group Of Pictures (GOP) will be closed. The selections are ENABLED or DISABLED.

BRIGHTNESS, CONTRAST, SATURATION and HUE: These menu items allow the user to assign the Brightness, Contrast, and Saturation parameters of the output video values from 0 to 255 with 128 being the default. The range and default values for Hue depends on the VIDEO INPUT mode. If Composite is selected, the range is 0 to 255. For all other VIDEO INPUT modes, the range is 0 to 128.

HORIZ SHIFT: This item allows the user to center the video horizontally in the outputted video signal. The values are from -300 to +300. This menu item will not appear if Composite or Component video input is selected.

HORIZ WIDTH: This item provides the means for the user to adjust the width of the outputted video. The values are from -300 to +300. This menu item will not appear if Composite or Component video input is selected.

AUDIO INPUT: The user may use this menu item to select the type of audio to be encoded. The selections are HDMI, S/PDIF, and ANALOG. Audio input jacks are provided on the rear panel for analog (see R4 on page 8), and S/PDIF (see R3 on page 8). In the case of HDMI, the audio is encoded along with the video and is inputted via the HDMI jack on the rear panel (see R8 on page 8).

QAM MODE: This menu allows the user to set the modulation type for the output. Choices are QAM-64B or QAM-256B. The B suffixes indicate DigiCipher II FEC encoding. For CATV systems using DigiCipher II, select the QAM-256B mode.

INTERLEAVER: This menu item provides the means to set the QAM modulator interleaver. Choose among the available selections based upon your system / set top box requirements. For typical 256-QAM DigiCipher II CATV systems, I128, J1 is the most commonly used interleave setting but many other choices are available.

OUTPUT FORMAT: For normal operation, select NORMAL. For system level set up, choose CW to provide a CW carrier at the center frequency of the output channel for use in leveling a system when a QAM power meter is not available. To disable all RF output, select STANDBY. In the CW mode, the CW carrier can be measured on a spectrum analyzer without a need to apply a bandwidth correction or it can be measured with an analog meter tuned to channel center. The CW power measured will equal the channel QAM power when the modulator is returned to NORMAL output mode. Usually QAM signals are set 5 dB to 10 dB below analog NTSC channels when balancing a system.

OUTPUT CHANMAP, OUTPUT CHANNEL: Select the desired EIA CATV channel output using these two menus.

OUTPUT LEVEL: Select the desired RF output signal level. The available range is between +29.5 dBmV and +45 dBmV, selectable in 0.5 dB steps. The output accuracy is ± 1 dB.

MGT/VCT ENABLE: This menu item provides a means for the user to select TVCT, CVCT 1-PART VCN, CVCT 2-PART VCN tables or DISABLED for QAM operation. TVCT is the typical setting.

CHANNEL NAME: The user can use this menu entry to name the channel. To do so, go to program mode by holding down the ENTER key until the bottom line of the display starts flashing. Then use the UP and DOWN keys to select the alphanumeric character and use the SELECT keys to move the cursor to the desired position in the channel name. The channel name cannot exceed 7 characters including any punctuation characters. This menu will not appear if 'Disabled' is selected in the MGT/VCT ENABLE menu.

MAJOR CHANNEL: This menu allows the user to select on which major channel the encoded audio and video information will appear. The choices are 1 through 999. If the MGT - VCT menu is set to 'DISABLE', this screen will not appear. If the 'MGT-VCT ENABLE' menu is set to 'CVCT 1-PART VCN' a single 'CHANNEL NUMBER' window will appear.

MINOR CHANNEL: This menu allows the user to determine the minor channel number on which the encoded audio and video information will appear. The choices are 1 through

999. If the MGT - VCT menu is set to DISABLE, this screen will not appear. If the 'MGT-VCT ENABLE' menu is set to 'CVCT 1-PART VCN' a single 'CHANNEL NUMBER' window will appear.

USER NAME: This menu entry allows the operator to enter a user name. As with CHANNEL NAME described previously, the LEFT and RIGHT SELECT buttons move the flashing cursor to any one of the 6 available positions. Then use the UP and DOWN buttons to scroll through the alphanumeric characters list until the desired character is displayed. Use one of the SELECT buttons to move to the next position. Repeat this procedure for each letter of the desired user name.

PASSWORD: Program in a password in this window. using the same technique described above for CHANNEL NAME and USER NAME. There are 8 cursor positions available.

HOST NAME: A host name may be entered in this window using the same technique described previously. There are 15 cursor positions available.

MAC ADDRESS: This menu item allows the user to view the MAC ADDRESS of the DSE24. This may be useful when debugging network connectivity issues. **WARNING: Do not change.** If necessary to reenter, see the label on the unit for proper MAC address.

DHCP: This window allows the DHCP (Dynamic Host Configuration Protocol) to be ENABLED or DISABLED. If DHCP is ENABLED, the DSE24 will automatically configure the IPADDRESS, SUBNET MASK, and GATEWAY ADDRESS, and these items will not be displayed in program mode. If it is DISABLED, these parameters will need to be configured manually and their menu pages will be displayed in program mode as well as in normal mode.

IP ADDRESS, SUBNET MASK, & GATEWAY ADDRESS: If DHCP is disabled, these three menu items will need to be programmed manually if the user intends to control the unit remotely with a PC. There are 4 cursor positions in each of these windows, and each position has a range of 000 to 255.

12 Operating Instructions (From the Front Panel)

OPERATING INSTRUCTIONS – FROM THE FRONT PANEL

- 1) Connect video and audio inputs to the appropriate rear panel input connections.
- 2) Connect the output connector (R1 on page 8) to the program distribution system as desired.
- 3) Plug the external power supply into the DC POWER jack (R2 on page 8) and plug the external power supply into AC power. Allow approximately 10 seconds for boot-up. Note that the DSE24 will be in the ON state whenever power is applied.
- 4) From the front panel, use the UP, DOWN, LEFT, RIGHT, ENTER and SELECT buttons to choose among DSE24 settings. Use the ENTER button to enter program mode and to save settings in memory. Use LEFT and RIGHT arrow buttons to select a parameter and then use the UP or DOWN arrows to change its value. Parameter values can only be changed when the unit is in the program mode as indicated by slow flashing of the bottom line of the front panel display.
- 5) Enter program mode by pressing the ENTER key and hold for 2 to 3 seconds.
- 6) Repeatedly press the left or right arrows (on either side of the enter button) until the display shows the parameter you wish to program. Press UP or DOWN arrows to select which value you choose for that particular parameter. Proceed in this manner until all parameters have been programmed to the desired values. When you reach the CHANNEL NAME parameter, use the LEFT and RIGHT SELECT buttons to position the flashing cursor to the desired position, and use the UP and DOWN arrows to select the alphanumeric character for that particular position.
- 7) Repeatedly press the LEFT or RIGHT arrows as required until the VIDEO INPUT screen is obtained. Then use the UP and DOWN arrows to select the correct video input.
- 8) Using the same technique, set the desired values for the RESOLUTION, ENCODE BITRATE, PROFILE, I-P INTERVAL, GOP FRAMES, CLOSED GOP, BRIGHTNESS, CONTRAST, SATURATION, HUE, HORIZ SHIFT, HORIZ WIDTH, AUDIO INPUT and AUDIO GAIN screens.
- 9) Press RIGHT arrow again and observe the QAM MODE screen. Use up or down arrows to select QAM mode. For example, QAM-256B would select 256 QAM with annex B FEC (DigiCipher FEC).
- 10) Press RIGHT arrow again and observe INTERLEAVER. Select I128,J1 unless you have a special requirement.
- 11) Press RIGHT arrow again and move to the OUTPUT FORMAT. Choose NORMAL. For testing/level setup, temporarily choose CW to produce a CW carrier in the center of the channel. To temporarily turn off the RF output without removing power from the DSE24, select STANDBY.
- 12) Press the RIGHT arrow button again and observe OUTPUT CHANMAP. Select the desired plan, usually CATV.
- 13) Press RIGHT arrow and observe OUTPUT CHANNEL. Select desired channel. The RF channel number being set will be used as the major channel number in the output stream.
- 14) Press RIGHT arrow button and observe OUTPUT LEVEL. Choose desired RF out level.
- 15) Press RIGHT arrow again. This should produce the QAM MGT/VCT ENABLE screen. Usually select TVCT by using up or down arrows.
- 16) Move on to the CHANNEL NAME screen using the RIGHT arrow button. There are seven cursor positions available for naming the channel. Use the UP and DOWN buttons to select the alphanumeric character for each of the seven positions and use the SELECT arrows to move the cursor to the desired character position. Note that this screen may not appear depending on the setting of the MGT/V ENABLE window.
- 17) Press RIGHT arrow and observe MAJOR CHANNEL. Select desired channel. The RF channel number being set will be used as the major channel number in the output stream. Note that this screen may not appear depending on the setting of the MGT/V ENABLE window.
- 18) Press RIGHT arrow and observe MINOR CHANNEL. Select desired channel. The RF channel number being set will be used as the minor channel number in the output stream. Note that this screen may not appear depending on the setting of the MGT/V ENABLE window.
- 19) Press ENTER to save all of the previous settings. If any of the settings need to be changed from the previously set values, re-enter program mode and adjust each parameter as required.
- 20) Press ENTER to store any unsaved changes.
- 21) To set the encoder to typical default settings, press the UP arrow, DOWN arrow, and ENTER buttons all at the same time. Hold the three buttons in for several seconds and release.

14 Additional Information

ADDITIONAL INFORMATION

STANDBY MODE

The DSE24 has a standby output mode which turns off the RF output. This can be used when it is desirable to temporarily disable the output without unplugging the external power supply. Select STANDBY in the 'OUTPUT FORMAT' menu.

OVER TEMPERATURE SENSOR

Temperature monitoring is built into this product. If inadequate ventilation is provided, overheating may occur. If this condition is detected, the default LCD message will change to OVER TEMP. If this occurs, the problem should be corrected as soon as possible. The unit will remain operational but the ventilation must be restored to prevent premature part failures due to overheating.

STATUS DISPLAYS

When the units are not in the program mode, status displays are shown. The default display shows the audio and video status. When the UP button is repeatedly pressed, the display toggles between the video and audio status and the version number.

The DOWN button causes the display to show the video and audio status but does not toggle.

REMOTE CONTROL AND MONITORING

The DSE24 may be used with a PC to allow remote monitoring or control.

Connect the Ethernet cable coming from the PC or router to the ETHERNET rear panel connector.

Assign a USER NAME, and PASSWORD to the DSE24 using the front panel controls as described previously. The PC must be running a web browser. Firefox is recommended.

Type either the USER NAME or IP ADDRESS in the browser's URL line and press the PC's ENTER button. The authentication window should appear. Type in the user name or IP address, enter the password you chose and click on OK. This should produce the parameters window. Then program the unit as described previously.

TABLE 1: CATV

CABLE TV CHANNELS	
Channel Number	Center of Channel
EIA/NCTA Numeric Equivalent	Frequency in MHz
2	57
3	63
4	69
5	79
6	85
95	93
96	99
97	105
98	111
99	117
14	123
15	129
16	135
17	141
18	147
19	153
20	159
21	165
22	171
7	177
8	183
9	189
10	195
11	201
12	207
13	213
23	219
24	225
25	231
26	237
27	243
28	249
29	255
30	261
31	267
32	273
33	279
34	285
35	291
36	297
37	303
38	309
39	315
40	321

CABLE TV CHANNELS	
Channel Number	Center of Channel
EIA/NCTA Numeric Equivalent	Frequency in MHz
41	327
42	333
43	339
44	345
45	351
46	357
47	363
48	369
49	375
50	381
51	387
52	393
53	399
54	405
55	411
56	417
57	423
58	429
59	435
60	441
61	447
62	453
63	459
64	465
65	471
66	477
67	483
68	489
69	495
70	501
71	507
72	513
73	519
74	525
75	531
76	537
77	543
78	549
79	555
80	561
81	567
82	573
83	579
84	585
85	591

CABLE TV CHANNELS	
Channel Number	Center of Channel
EIA/NCTA Numeric Equivalent	Frequency in MHz
86	597
87	603
88	609
89	615
90	621
91	627
92	633
93	639
94	645
100	651
101	657
102	663
103	669
104	675
105	681
106	687
107	693
108	699
109	705
110	711
111	717
112	723
113	729
114	735
115	741
116	747
117	753
118	759
119	765
120	771
121	777
122	783
123	789
124	795
125	801
126	807
127	813
128	819
129	825
130	831
131	837
132	843
133	849
134	855
135	861

CABLE TV CHANNELS	
Channel Number	Center of Channel
EIA/NCTA Numeric Equivalent	Frequency in MHz
136	867
137	873
138	879
139	885
140	891
141	897
142	903
143	909
144	915
145	921
146	927
147	933
148	939
149	945
150	951
151	957
152	963
153	969
154	975
155	981
156	987
157	993
158	999

16 Broadcast TV & T Channel Frequencies

TABLE 2: BC TV & T CHANNELS

VHF BROADCAST CHANNELS	
Channel Number	Center of Channel Frequency (MHz)
2	57
3	63
4	69
5	79
6	85
7	177
8	183
9	189
10	195
11	201
12	207
13	213

T CHANNELS	
Channel Number	Center of Channel Frequency (MHz)
7	8.75
8	14.75
9	20.75
10	26.75
11	32.75
12	38.75
13	44.75
14	50.75

UHF BROADCAST CHANNELS	
Channel Number	Center of Channel Frequency (MHz)
14	473
15	479
16	485
17	491
18	497
19	503
20	509
21	515
22	521
23	527
24	533
25	539
26	545
27	551
28	557
29	563
30	569
31	575
32	581
33	587
34	593
35	599
36	605
37	611
38	617
39	623
40	629
41	635
42	641
43	647
44	653
45	659
46	665
47	671
48	677
49	683
50	689
51	695
52	701
53	707
54	713
55	719
56	725
57	731
58	737
59	743
60	749
61	755
62	761
63	767
64	773
65	779
66	785
67	791
68	797
69	803

SERVICE INFORMATION

You may contact the R.L. DRAKE Service Department for additional information or assistance by calling +1 (937) 746-6990, Monday through Friday, between 8:00 A.M. and 4:00 P.M. Eastern Time, except on holidays.

You may also contact the R.L. DRAKE Service Department by E-mail at the following address:
TechSupport@rldrake.com
or by Telefax:
+1 (937) 806-1576.

Should you want to return your unit for service, package the unit carefully using the original carton or other suitable container.

Write your return address clearly on the shipping carton and on an enclosed cover letter describing the service required, symptoms or problems. Also include your daytime telephone number and a copy of your proof of purchase.

The unit will be serviced under the terms of the R.L. DRAKE LLC Limited Warranty and returned to you.

IF YOU NEED TO CALL FOR HELP

Call our Customer Service/Technical Support line at +1 (937) 746-6990 between 8:00 A.M. and 4:00 P.M. Eastern Time, weekdays. Please have the unit's serial number available. We will also need to know the specifics of any other equipment connected to the unit. When calling, please have the unit up and running, near the phone if possible. Our technician(s) will likely ask certain questions to aid in diagnosis of the problem. Also, have a voltmeter handy, if possible.

R.L. DRAKE also provides technical assistance by e-mail: TechSupport@rldrake.com
or by Telefax: +1 (937) 806-1576.

Many of the products that are sent to us for repair are in perfect working order when we receive them. For these units, there is a standard checkout fee that you will be charged. Please perform whatever steps are applicable from the installation sections of the Owner's Manual before calling or writing—this could save unnecessary phone charges. Please do not return the unit without contacting R.L. DRAKE first: it is preferred to help troubleshoot the problem over the phone (or by mail) first, saving you both time and money.

Inside the carton, enclose a note with your name, address, daytime phone number, and a description of the unit's problem.

The unit must be sent to the following address:

**Service Department
R.L. DRAKE LLC
230 Industrial Drive
Franklin, Ohio 45005 U.S.A.**

Be sure to include your street address which will be needed for UPS return. UPS Surface (Brown Label) takes 7-10 days to reach us depending on your location, Blue takes 2-3 days.

Red is an overnight service. Send the unit in a way that it can be traced if we can't verify receipt of shipment. We suggest UPS or insured postal shipment.

If the unit is still under the original owner's warranty, R.L. DRAKE will pay the cost of the return shipment to you. Our return shipping policy is that we will return it UPS Brown if received Brown or by US Mail, it will be returned Blue if received Blue or Red—or it will be returned however you prefer if you furnish the return cost for the method you select.

If the unit is out of warranty, use one of the following methods for return shipment:

- 1) You designate billing to American Express, VISA, MasterCard or Discover card;
- 2) You prepay the service charges with a personal check, or
- 3) You specify some other method of return and payment.

When calling, the technician can estimate the repair charges for you over the phone. This is another good reason to call before sending a unit in for repair. Typically, equipment is repaired in five to ten working days after it arrives at R.L. DRAKE if we have all the facts. If we must call you, it may take longer. R.L. DRAKE is not responsible for damage caused by lightning, nonprofessional alterations, "acts of God", shipping damage, poor storage/handling, etc. R.L. DRAKE will make note of any shipping damage upon receipt.

You will need to send proof of purchase to receive warranty service. Typically, a copy of the invoice from an R.L. DRAKE dealer will suffice. The warranty is for the original owner only and is not transferable.

One Year Limited Warranty

R.L. DRAKE LLC warrants to the original purchaser this product shall be free from defects in material or workmanship for one (1) year from the date of original purchase.

During the warranty period the R.L. DRAKE LLC or an authorized Drake service facility will provide, free of charge, both parts and labor necessary to correct defects in material and workmanship. At its option, R.L. DRAKE LLC may replace a defective unit.

To obtain such a warranty service, the original purchaser must:

- (1) Retain invoice or original proof of purchase to establish the start of the warranty period.
- (2) Notify the R.L. DRAKE LLC or the nearest authorized service facility, as soon as possible after discovery of a possible defect, of:
 - (a) the model and serial number,
 - (b) the identity of the seller and the approximate date of purchase; and
 - (c) A detailed description of the problem, including details on the electrical connection to associated equipment and the list of such equipment.
- (3) Deliver the product to the R.L. DRAKE LLC or the nearest authorized service facility, or ship the same in its original container or equivalent, fully insured and shipping charges prepaid.

Correct maintenance, repair, and use are important to obtain proper performance from this product. Therefore carefully read the Instruction Manual. This warranty does not apply to any defect that R.L. DRAKE LLC determines is due to:

- (1) Improper maintenance or repair, including the installation of parts or accessories that do not conform to the quality and specifications of the original parts.
- (2) Misuse, abuse, neglect or improper installation.
- (3) Accidental or intentional damage.

All implied warranties, if any, including warranties of merchantability and fitness for a particular purpose, terminate one (1) year from the date of the original purchase.

The foregoing constitutes R.L. DRAKE LLC'S entire obligation with respect to this product, and the original purchaser shall have no other remedy and no claim for incidental or consequential damages, losses or expenses. Some states do not allow limitations on how long an implied warranty lasts or do not allow the exclusions or limitation of incidental or consequential damages, so the above limitation and exclusion may not apply to you.

This warranty gives you specific legal rights and you may also have other rights which vary from state to state. This warranty shall be construed under the laws of Ohio.

For Service, contact:

R.L. DRAKE LLC
230 Industrial Drive
Franklin, Ohio 45005 U.S.A.
Customer Service and Parts Telephone: +1 (937) 746-6990
Telefax: +1 (937) 806-1576
World Wide Web Site: <http://www.rldrake.com>



R.L. Drake LLC

230 Industrial Drive

Franklin, Ohio 45005 U.S.A.

Customer Service and Parts Telephone: +1 (937) 746-6990

Telefax: +1 (937) 806-1576

World Wide Web Site: <http://www.rldrake.com>